

Visualization of Graphs

Lecture 1a: The Graph Visualization Problem

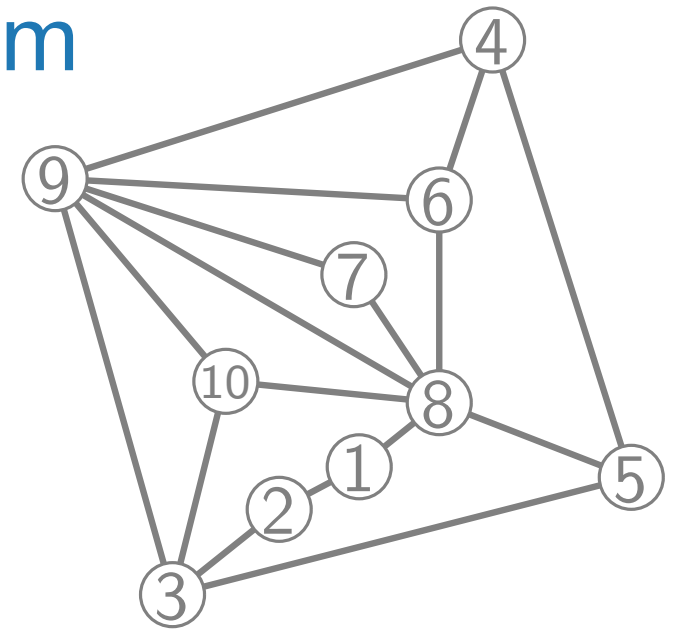
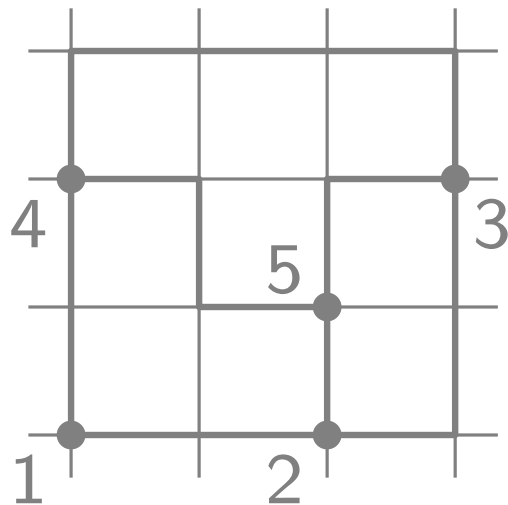
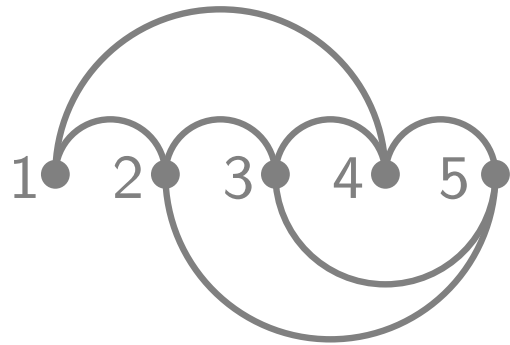

Johannes Zink

Organizational

Lectures:

- Johannes Zink (M4, room 01.007, johannes.zink@uni-wuerzburg.de)
- Friday, 10:15–11:45, SE II
- videos (in German) from 2021 by Jonathan Klawitter available on WueCampus

Tutorials:

- Oksana Firman (M4, room 01.005, oksana.firman@uni-wuerzburg.de)
- Wednesday, 16:00–17:30, SE 8 physics building (first tutorial: April 26)
- one exercise sheet each week (Friday to Friday; first sheet appears today)
- 20 points per sheet
- average score 50% or more \Rightarrow bonus of 0.3 grade points
- submit solutions online (WueCampus)
- we recommend using \LaTeX – template on WueCampus!
- discussions and solutions...

Books

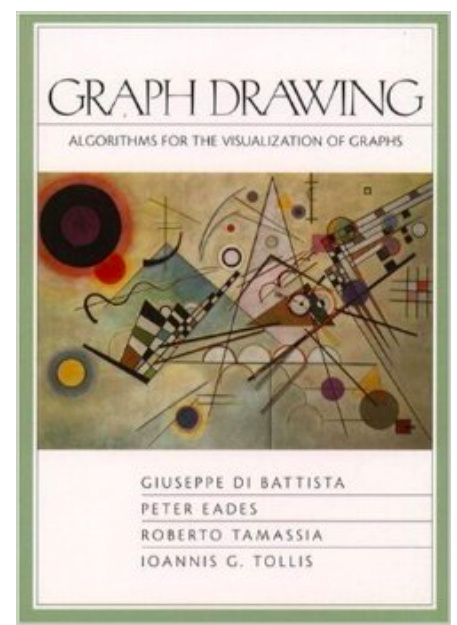

G. Di Battista, P. Eades, R. Tamassia, I. Tollis:
 Graph Drawing: Algorithms for the Visualization of Graphs
 Prentice Hall, 1998

[GD]

[DG]

M. Kaufmann, D. Wagner:
 Drawing Graphs: Methods and Models
 Springer, 2001

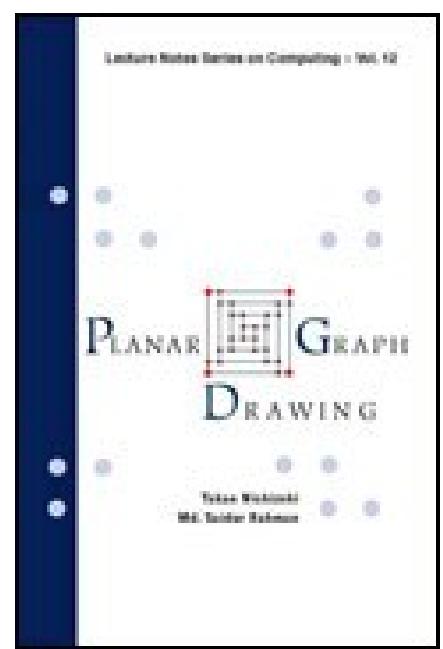
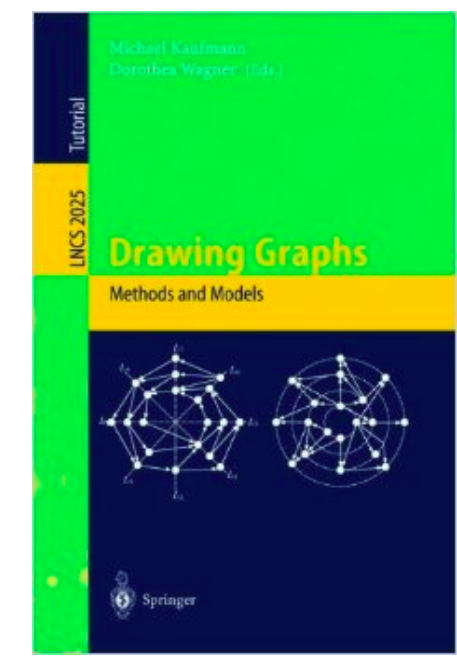

T. Nishizeki, Md. S. Rahman:
 Planar Graph Drawing
 World Scientific, 2004

[PGD]

[HGDTV]

R. Tamassia:
 Handbook of Graph Drawing and Visualization
 CRC Press, 2013

<http://cs.brown.edu/people/rtamassi/gdhandbook/>

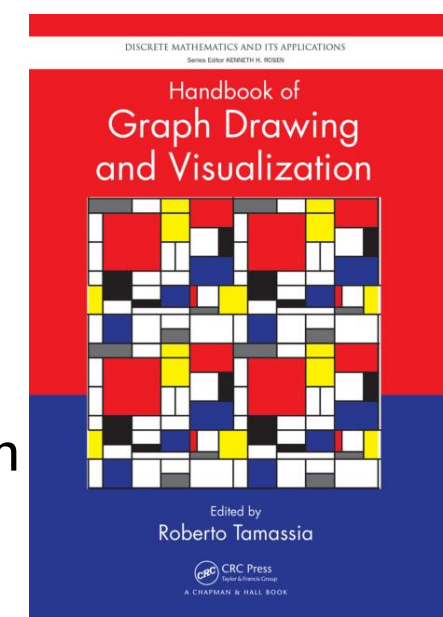

What Is This Course About?

Learning objectives

- Overview of graph visualization
- Improved knowledge of modeling and solving problems via graph algorithms

Visualization problem:

- Given a graph G , visualize it with a drawing Γ

Here:

- Reducing the visualization problem to its **algorithmic core**

graph class \Rightarrow layout style \Rightarrow algorithm \Rightarrow analysis

- modeling
- data structures
- divide & conquer, incremental
- combinatorial optimization (flows, ILPs)
- force-based algorithm
- proofs

What Is This Course About?

Topics

- Drawing Trees and Series-Parallel Graphs
- Tutte Embedding and Force-Based Drawing Algorithms
- Straight-Line Drawings of Planar Graphs
- Orthogonal Grid Drawings
- Octilinear Drawings for Metro Maps
- Upwards Planar Drawings
- Hierarchical Layouts of Directed Graphs
- Contact Representations
- Visibility Representations
- The Crossing Lemma
- Beyond Planarity

Graphs and Their Representations

What is a graph?

- graph $G = (V, E)$
- vertices $V = \{v_1, v_2, \dots, v_n\}$
- edges $E = \{e_1, e_2, \dots, e_m\}$,
where each edge is a pair from V

Representation?

■ Set notation

$$V = \{v_1, v_2, v_3, v_4, v_5, v_6, v_7, v_8, v_9, v_{10}\}$$

$$E = \{\{v_1, v_2\}, \{v_1, v_8\}, \{v_2, v_3\}, \{v_3, v_5\}, \{v_3, v_9\}, \{v_3, v_{10}\}, \{v_4, v_5\}, \{v_4, v_6\}, \{v_4, v_9\}, \{v_5, v_8\}, \{v_6, v_8\}, \{v_6, v_9\}, \{v_7, v_8\}, \{v_7, v_9\}, \{v_8, v_{10}\}, \{v_9, v_{10}\}\}$$

■ Adjacency list

$v_1:$	v_2, v_8	$v_6:$	v_4, v_8, v_9
$v_2:$	v_1, v_3	$v_7:$	v_8, v_9
$v_3:$	v_2, v_5, v_9, v_{10}	$v_8:$	$v_1, v_5, v_6, v_7, v_9, v_{10}$
$v_4:$	v_5, v_6, v_9	$v_9:$	$v_3, v_4, v_6, v_7, v_8, v_{10}$
$v_5:$	v_3, v_4, v_8	$v_{10}:$	v_3, v_8, v_9

■ Adjacency matrix

$$\begin{pmatrix} 0 & 1 & 0 & 0 & 0 & 0 & 0 & 0 & 1 & 0 & 0 \\ 1 & 0 & 1 & 0 & 0 & 0 & 0 & 0 & 0 & 0 & 0 \\ 0 & 1 & 0 & 0 & 1 & 0 & 0 & 0 & 0 & 1 & 1 \\ 0 & 0 & 0 & 0 & 1 & 1 & 0 & 0 & 0 & 1 & 0 \\ 0 & 0 & 1 & 1 & 0 & 0 & 0 & 0 & 1 & 0 & 0 \\ 0 & 0 & 0 & 1 & 0 & 0 & 0 & 0 & 1 & 1 & 0 \\ 0 & 0 & 0 & 0 & 0 & 0 & 0 & 0 & 1 & 1 & 0 \\ 1 & 0 & 0 & 0 & 1 & 1 & 1 & 0 & 1 & 1 & 1 \\ 0 & 0 & 1 & 1 & 0 & 1 & 1 & 1 & 1 & 0 & 1 \\ 0 & 0 & 1 & 0 & 0 & 0 & 0 & 0 & 1 & 1 & 0 \end{pmatrix}$$

■ Drawing

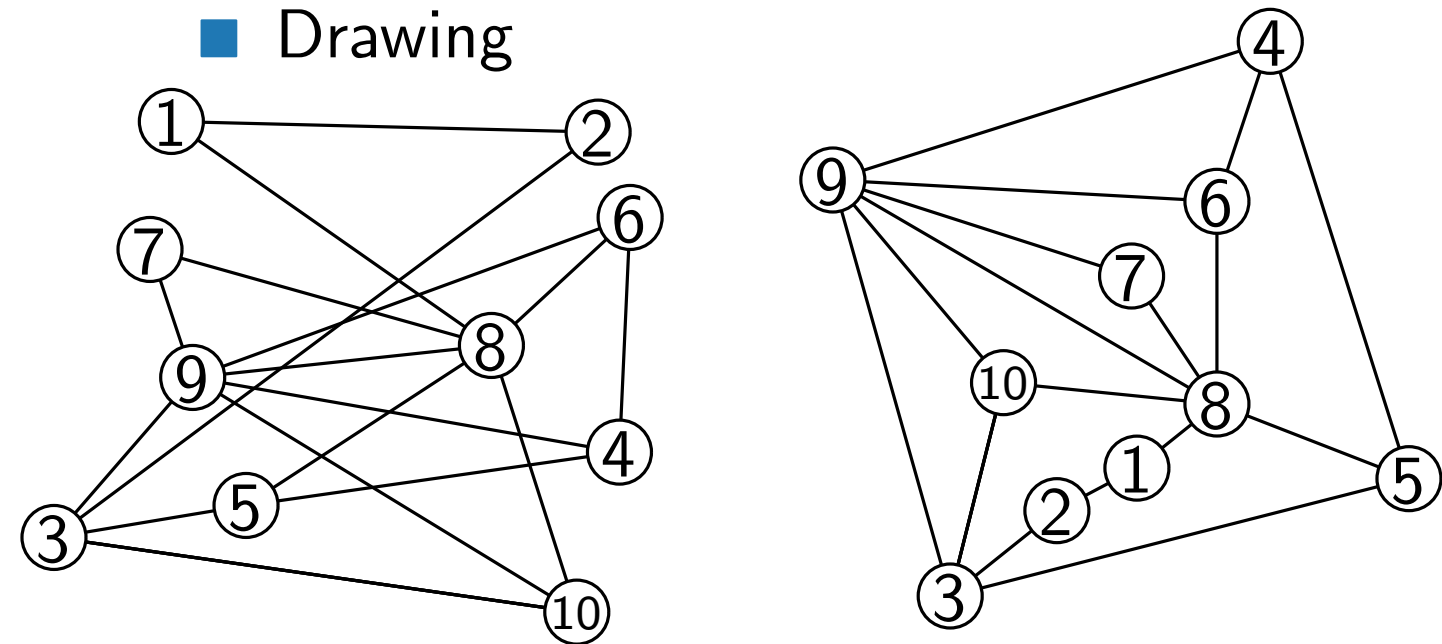

Why to Draw Graphs?

Graphs are a mathematical representation of real physical and abstract networks.

Physical networks

- Metro systems
- Road networks
- Power grids
- Telecommunication networks
- Integrated circuits
- ...

Abstract networks

- Social networks
- Communication networks
- Phylogenetic networks
- Metabolic networks
- Class/Object Relation Digraphs (UML)
- ...

Why to Draw Graphs?

Graphs are a mathematical representation of real physical and abstract networks.

- **People think visually** – complex graphs are hard to grasp without good visualizations!

Why to Draw Graphs?

Graphs are a mathematical representation of real physical and abstract networks.

- **People think visually** – complex graphs are hard to grasp without good visualizations!
- Visualizations help with the **communication** and **exploration** of networks.
- Some graphs are too big to draw them by hand.

We need algorithms that draw graphs automatically to make networks more accessible to humans.

What Are We Interested In?

- Jacques Bertin defined *visualization variables* (1967)

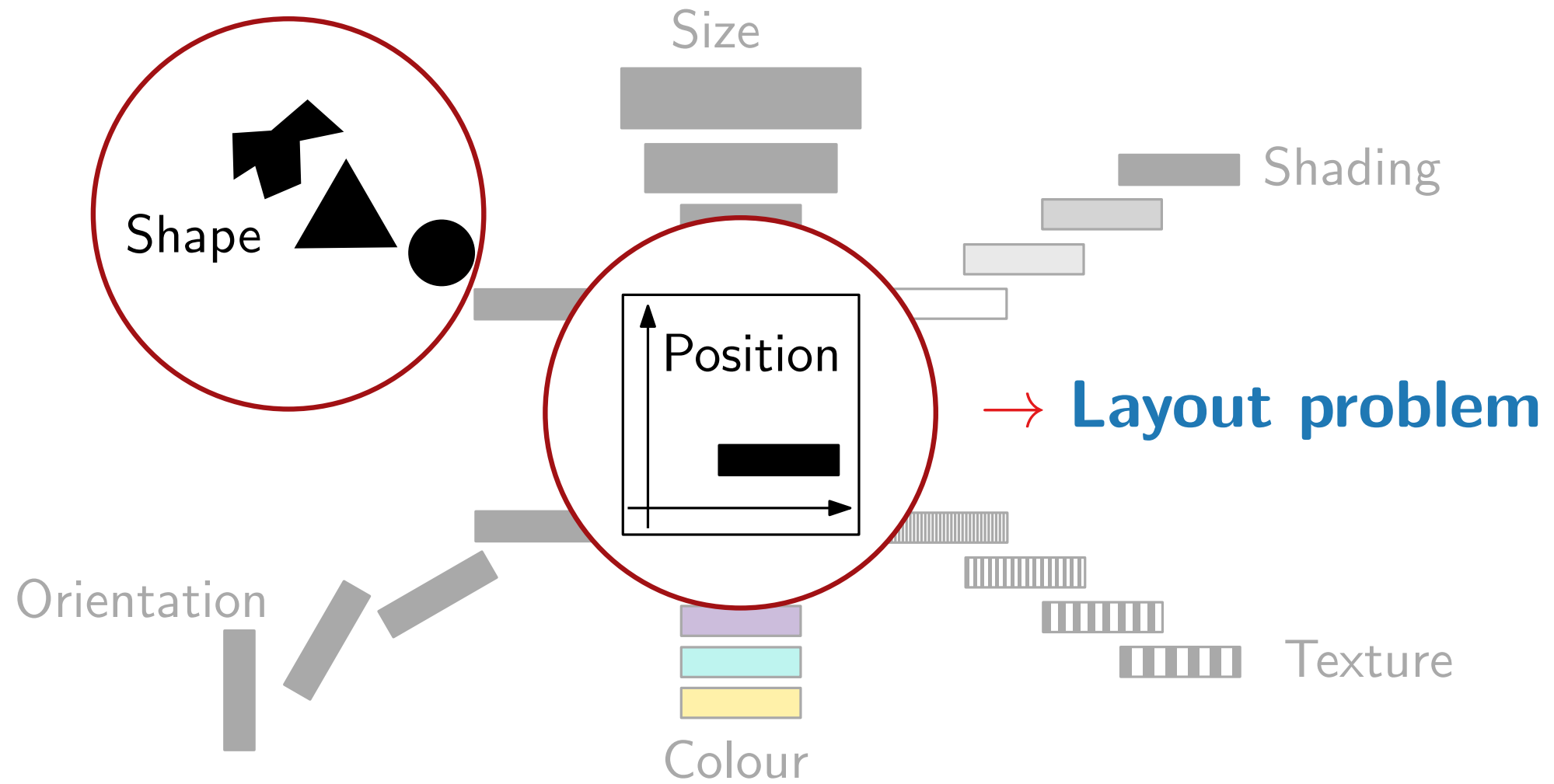

The Layout Problem?

- Here restricted to the **standard representation**, so-called node-link diagrams.

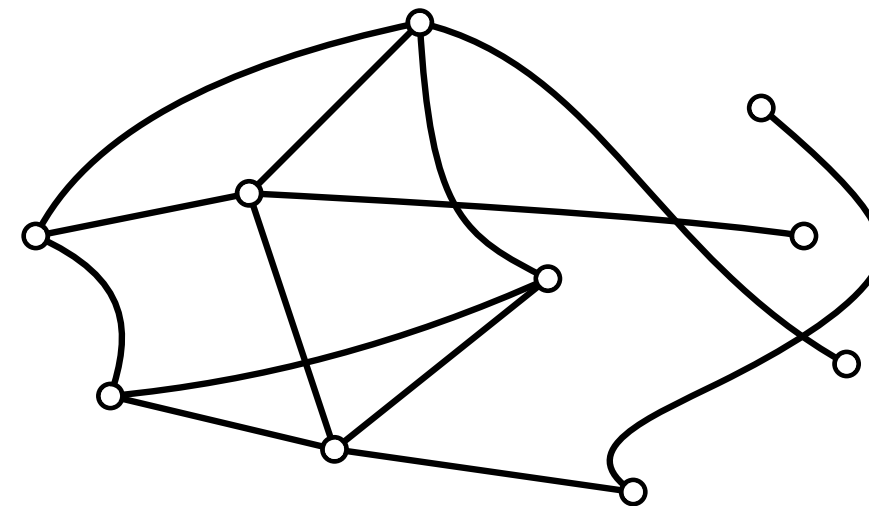

Graph Visualization Problem

in: graph G

out: **nice** drawing Γ of G

- $\Gamma: V(G) \rightarrow \mathbb{R}^2$, vertex $v \mapsto$ point $\Gamma(v)$

- $\Gamma: E(G) \rightarrow$ simple, open curves in \mathbb{R}^2
 $\{u, v\} \mapsto \Gamma(\{u, v\})$ with endpoints $\Gamma(u)$ and $\Gamma(v)$

But what is a **nice** drawing?

Requirements of a Graph Layout

1. Drawing conventions and requirements, e.g.,

- straight edges with $\Gamma(uv) = \overline{\Gamma(u)\Gamma(v)}$
- orthogonal edges (with bends)
- grid drawings
- without crossing

2. Aesthetics to be optimized, e.g.

- crossing/bend minimization

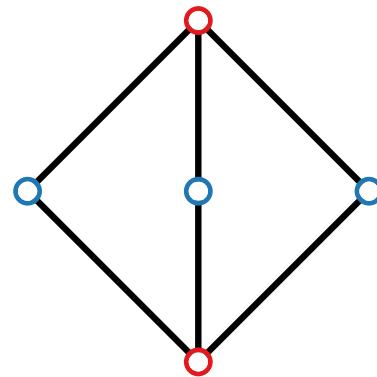
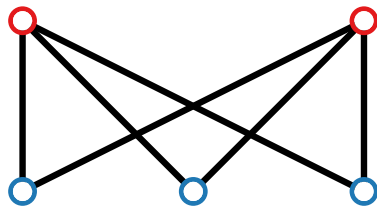
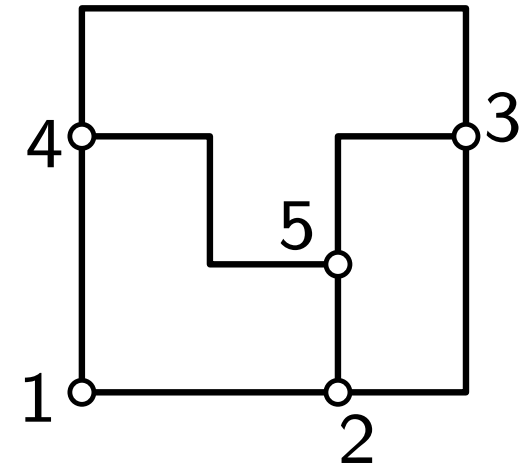
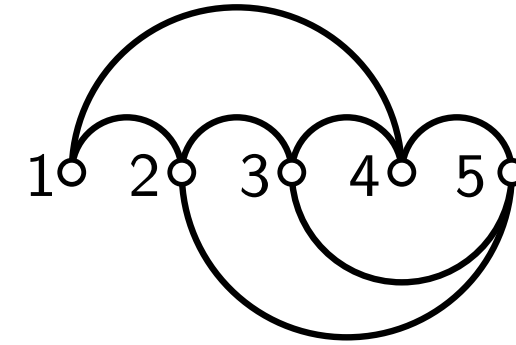
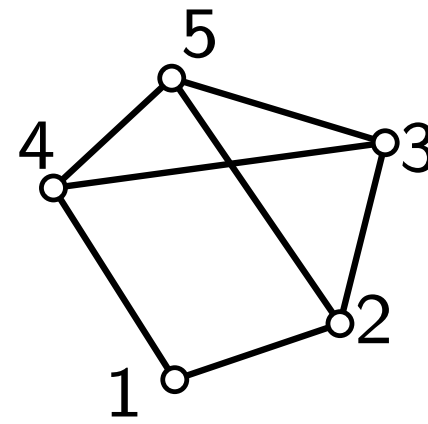

Requirements of a Graph Layout

1. Drawing conventions and requirements, e.g.,

- straight edges with $\Gamma(uv) = \overline{\Gamma(u)\Gamma(v)}$
- orthogonal edges (with bends)
- grid drawings
- without crossing

2. Aesthetics to be optimized, e.g.

- crossing/bend minimization

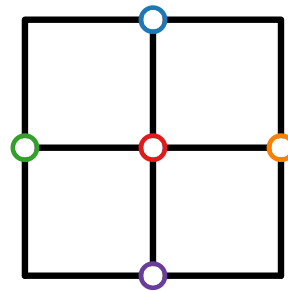
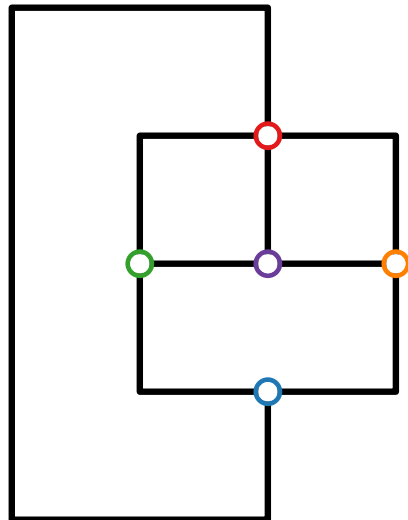
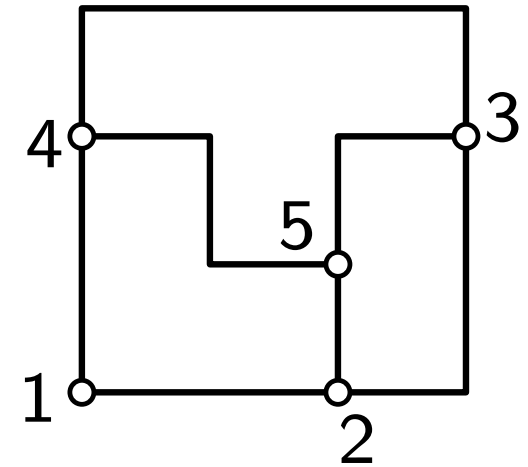
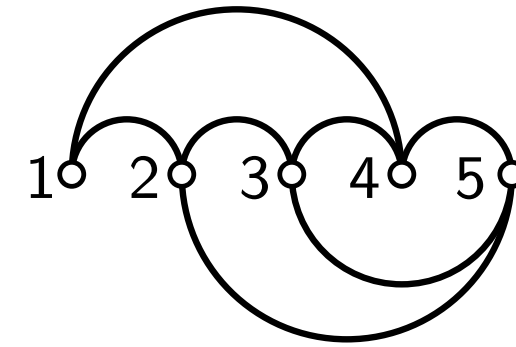
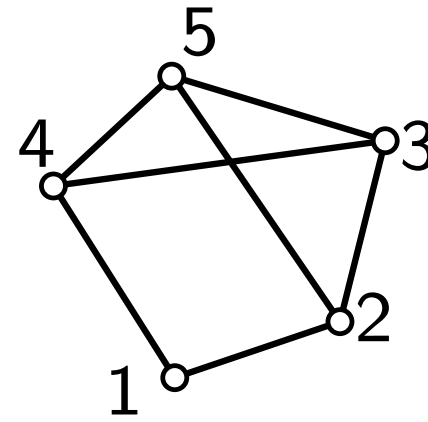

Requirements of a Graph Layout

1. Drawing conventions and requirements, e.g.,

- straight edges with $\Gamma(uv) = \overline{\Gamma(u)\Gamma(v)}$
- orthogonal edges (with bends)
- grid drawings
- without crossing

2. Aesthetics to be optimized, e.g.

- crossing/bend minimization
- edge length uniformity

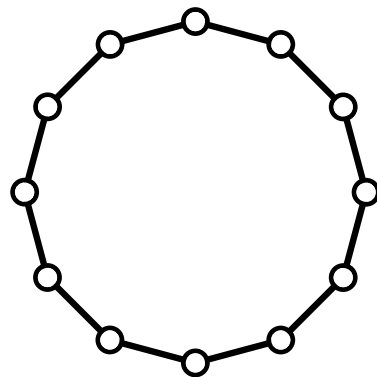
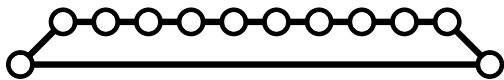
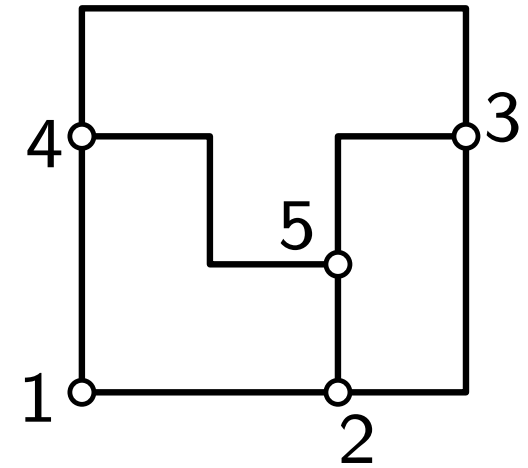
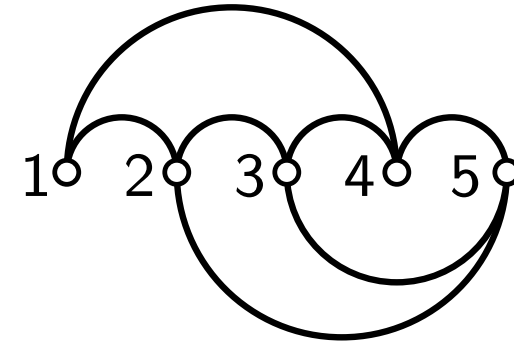
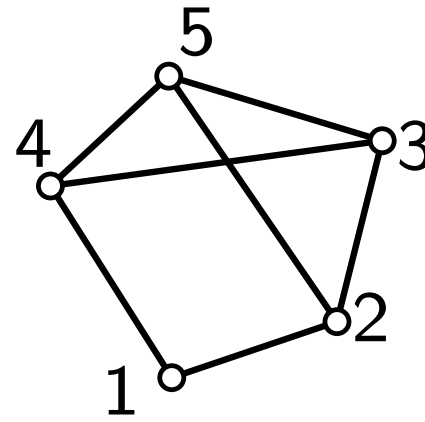

Requirements of a Graph Layout

1. Drawing conventions and requirements, e.g.,

- straight edges with $\Gamma(uv) = \overline{\Gamma(u)\Gamma(v)}$
- orthogonal edges (with bends)
- grid drawings
- without crossing

2. Aesthetics to be optimized, e.g.

- crossing/bend minimization
- edge length uniformity
- minimizing total edge length/drawing area

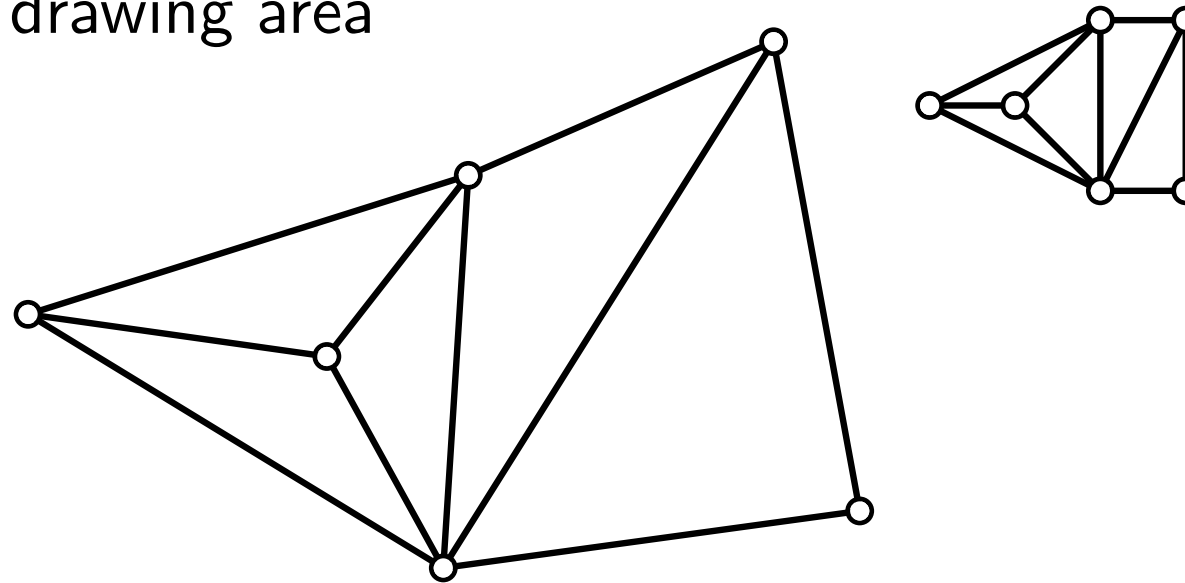
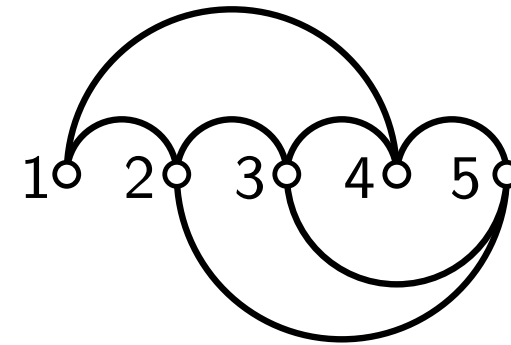
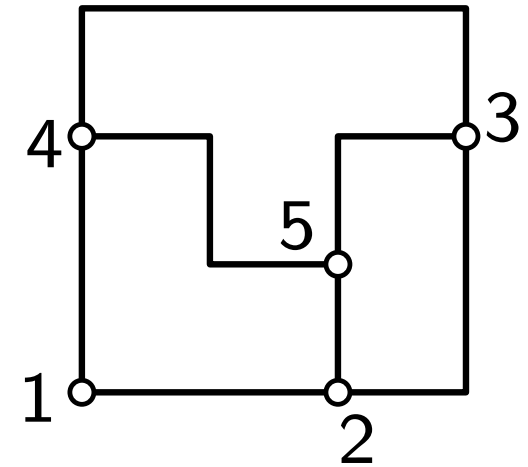
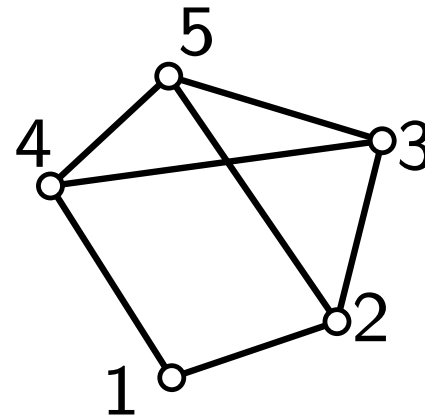

Requirements of a Graph Layout

1. Drawing conventions and requirements, e.g.,

- straight edges with $\Gamma(uv) = \overline{\Gamma(u)\Gamma(v)}$
- orthogonal edges (with bends)
- grid drawings
- without crossing

2. Aesthetics to be optimized, e.g.

- crossing/bend minimization
- edge length uniformity
- minimizing total edge length/drawing area
- angular resolution

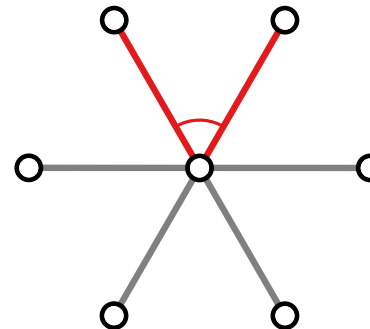
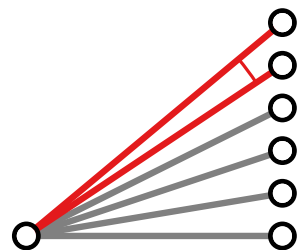
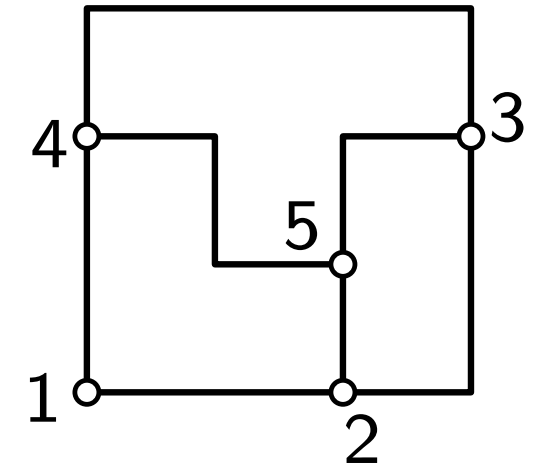
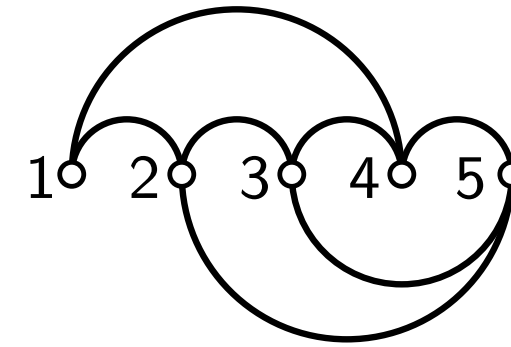
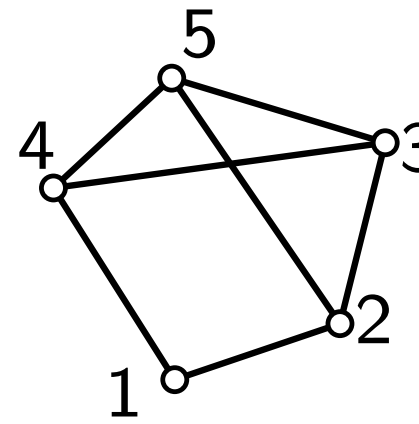

Requirements of a Graph Layout

1. Drawing conventions and requirements, e.g.,

- straight edges with $\Gamma(uv) = \overline{\Gamma(u)\Gamma(v)}$
- orthogonal edges (with bends)
- grid drawings
- without crossing

2. Aesthetics to be optimized, e.g.

- crossing/bend minimization
- edge length uniformity
- minimizing total edge length/drawing area
- angular resolution

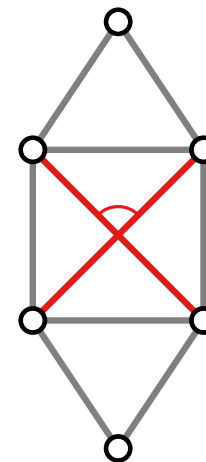
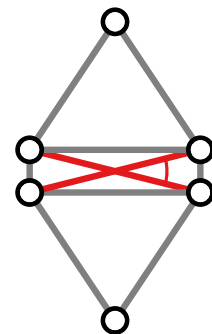
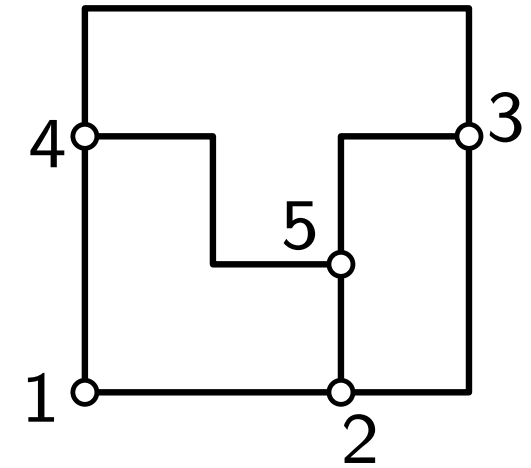
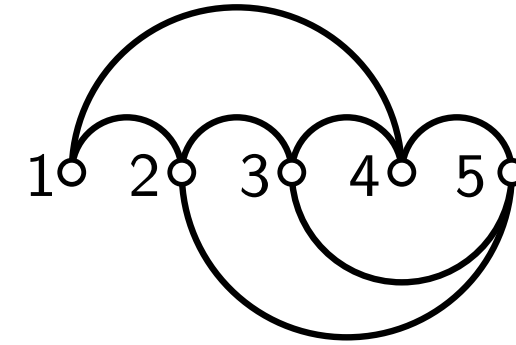
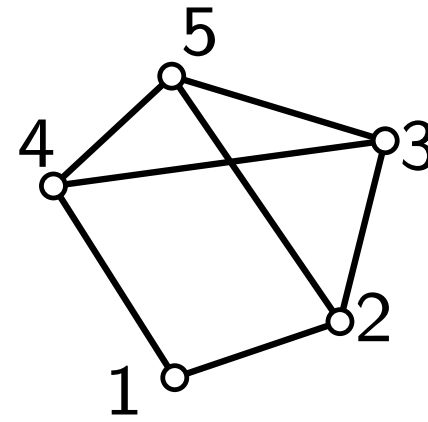

Requirements of a Graph Layout

1. Drawing conventions and requirements, e.g.,

- straight edges with $\Gamma(uv) = \overline{\Gamma(u)\Gamma(v)}$
- orthogonal edges (with bends)
- grid drawings
- without crossing

2. Aesthetics to be optimized, e.g.

- crossing/bend minimization
- edge length uniformity
- minimizing total edge length/drawing area
- angular resolution
- symmetry/structure

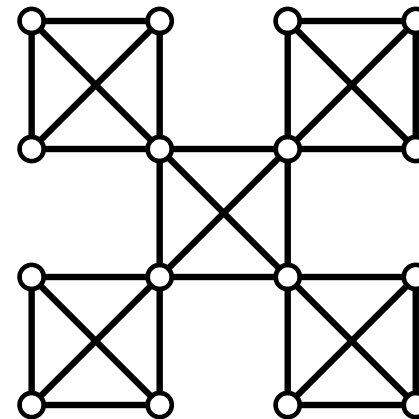
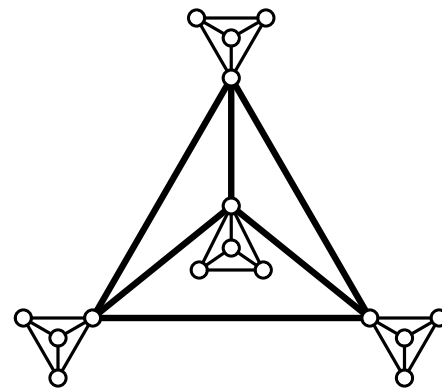
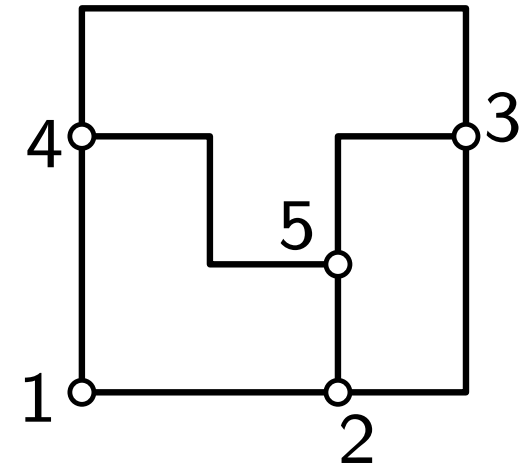
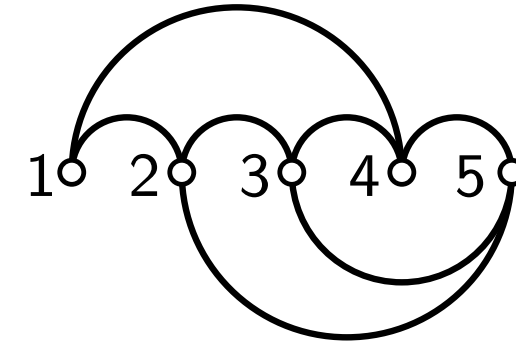
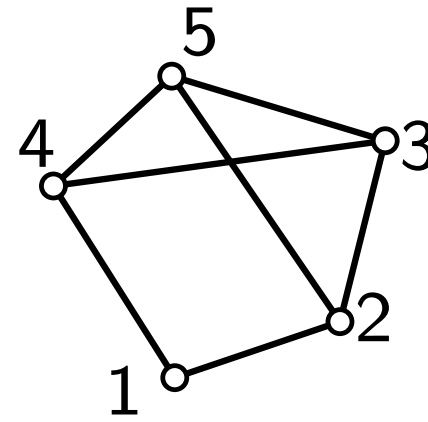

Requirements of a Graph Layout

1. Drawing conventions and requirements, e.g.,

- straight edges with $\Gamma(uv) = \overline{\Gamma(u)\Gamma(v)}$
- orthogonal edges (with bends)
- grid drawings
- without crossing

2. Aesthetics to be optimized, e.g.

- crossing/bend minimization
- edge length uniformity
- minimizing total edge length/drawing area
- angular resolution
- symmetry/structure

3. Local Constraints, e.g.

- restrictions on neighboring vertices (e.g., “upward”).
- restrictions on groups of vertices/edges (e.g., “clustered”).

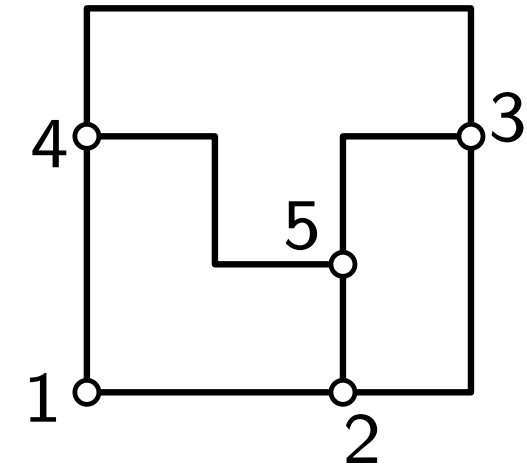
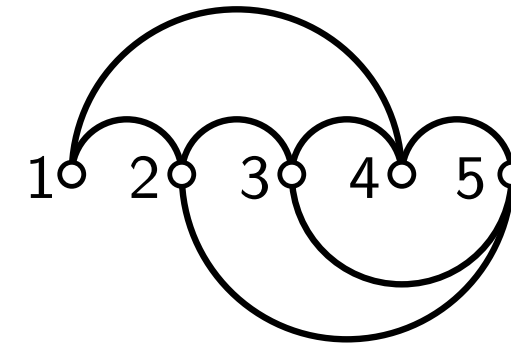
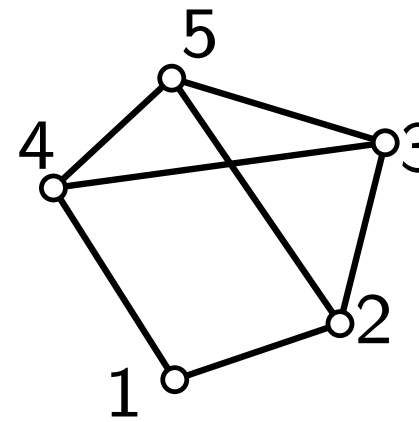

→ such criteria are often inversely related

→ lead to NP-hard optimization problems

The Layout Problem

Graph visualization problem

in: Graph G

out: Drawing Γ of G such that

- **drawing conventions** are met,
- **aesthetic criteria** are optimized, while
- some **additional constraints** are satisfied.

Graph Drawing Contest 2023

- We have seen, it is not always clear how a *nice* graph visualizations looks like.
- Therefore, there is a contest about graph drawing co-located to the annual International Symposium on Graph Drawing and Network Visualization (GD).
- September 20, 2023, Isola delle Femmine, Sicily, Italy
<https://mozart.diei.unipg.it/gdcontest/2023/>
- Creative topic: *Board-Game Recommendations*
- Live Challenge: *Crossing-Minimal Point-Set Embedding*
 - given: a set of points on the grid and a graph
 - task: assign the vertices to the points
 - objective function: minimize the number of crossings
- Interested in implementing a program for the live challenge? May be done as a Praktikum!